



Owner's Manual

THE WAVELINE™
FLUTE



Specifications subject to change without notice
www.JUPITERmusic.com



JUPITER.



Contents

The Waveline™ D Flute

- 1. Assembly 1
- 2. Disassembly 2
- 3. Inspection & Maintenance 3

The Waveline™ C Flute

- 1. Assembly 5
- 2. Disassembly 8
- 3. Inspection & Maintenance 8
- 4. Optional Waveline™ Flute Extension Kit 10
- 5. How to use the Waveline™ Flute Extension Kit 11

The Waveline™ D Flute

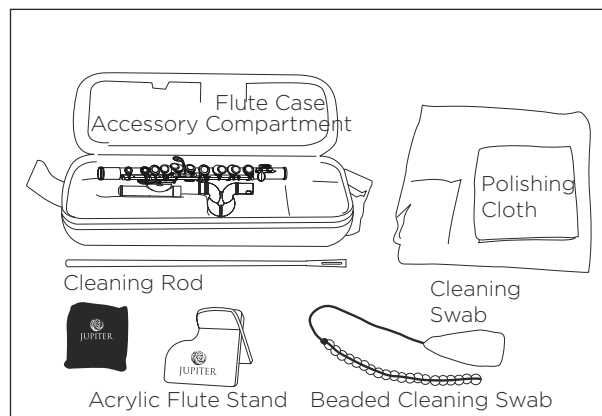

1 Assembly

Step 1.
Hold the Waveline bowjoint.
Insert headjoint with a
gentle twisting motion.

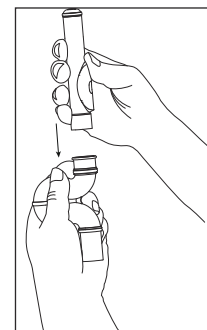

Step 2.
Insert the Waveline bow
headjoint assembly with a
gentle twisting motion.

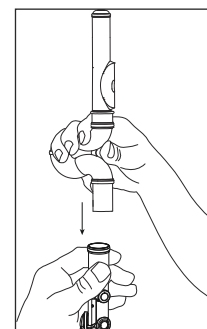

Step 3.

Adjust the lip plate so the embouchure hole is in line with the C# key on the bodyjoint.

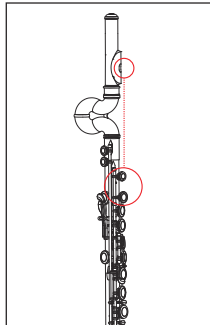

Step 4.

When not playing your flute, place it on the acrylic flute stand included with your instrument.

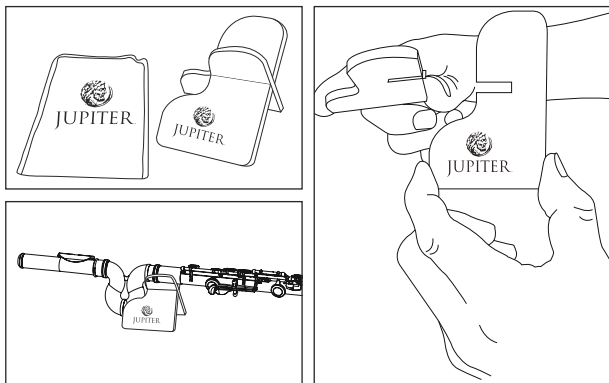

2 Disassembly

Step 1.

Hold and remove the headjoint from the Waveline bowjoint with a gentle twisting motion.

Step 2.

Hold the bodyjoint and remove it from the Waveline bowjoint with a gentle twisting motion.

3 Inspection & Maintenance

1. How to clean the Waveline bowjoint:

Insert the beaded cleaning swab through the Waveline bowjoint to remove excess moisture.

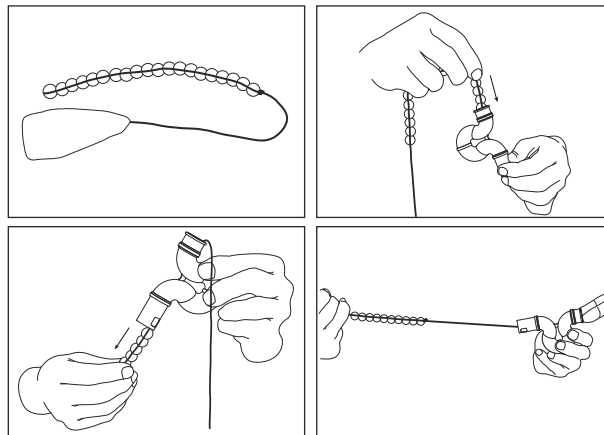

2. How to clean the inner tubes (headjoint, bodyjoint, and footjoint)

Pull one corner of the swab through the end of the cleaning rod. Wrap the remaining cloth around the cleaning rod.

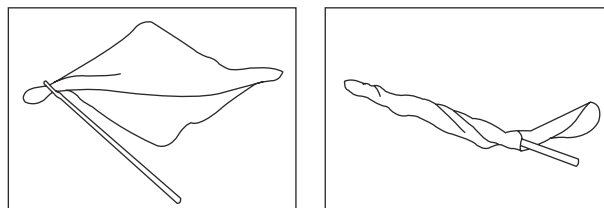

Insert the cleaning swab through the headjoint, bodyjoint, and footjoint to remove excess moisture.



The Waveline™ C Flute

3. How to clean/polish the flute's surface:

After playing, wipe the instrument's surface with a soft polishing cloth. When wiping, hold the instrument carefully as to not damage delicate key mechanisms or pads.

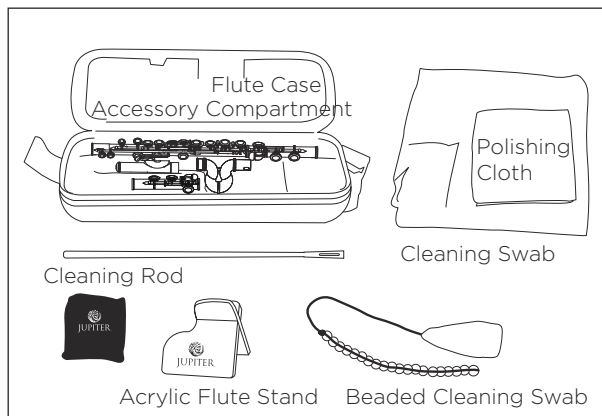
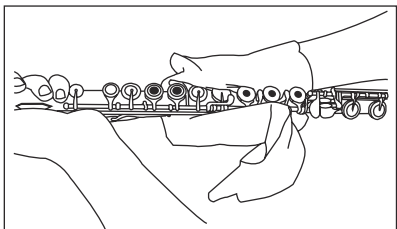

1 Assembly

Step 1.
Hold the barrel at the key post using the thumb and forefinger.

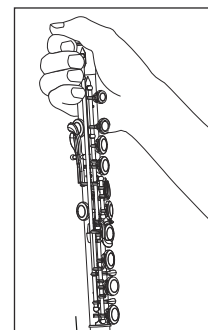

Step 2.
Connect the footjoint to the bodyjoint with a gentle twisting motion. Avoid depressing the keys during assembly.

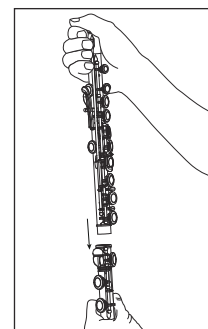

Step 3.
Insert headjoint into the
Waveline bowjoint with a
gentle twisting motion.

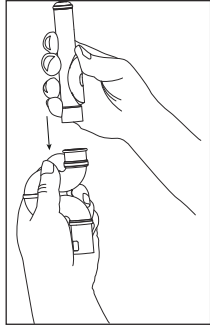

Step 4.
Insert the Waveline bow headjoint
assembly into the bodyjoint using a gentle
twisting motion. Adjust the lip plate so the
embouchure hole is in line with the C# key on
the bodyjoint.

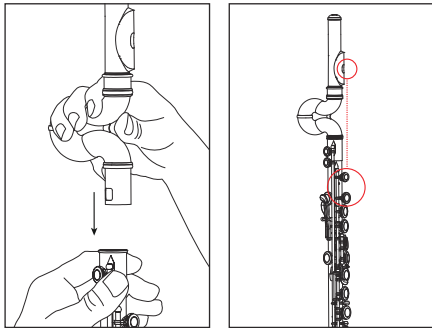

Step 5.
The specially engraved alignment indicators
located on the headjoint and bodyjoint
ensure correct assembly and optimum
position placement.

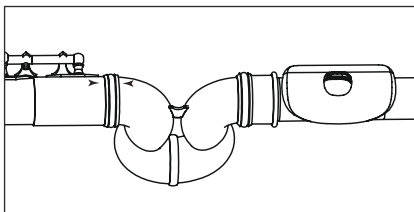

Step 6.
When not playing, place your flute on
the acrylic flute stand included with your
instrument.

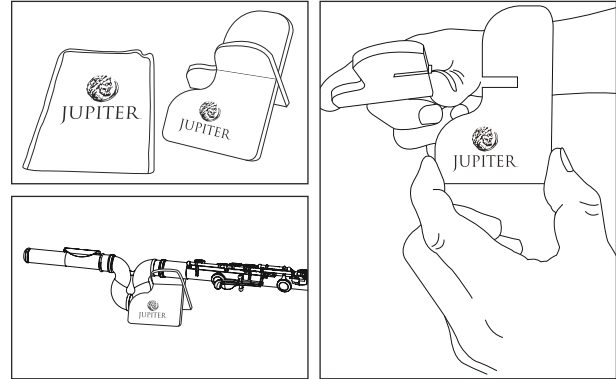

2 Disassembly

Step 1.

Hold and remove the headjoint from the Waveline bowjoint with a gentle twisting motion.

Step 2.

Hold the bodyjoint and remove it from the Waveline bowjoint with a gentle twisting motion.

2. How to clean the inner tubes (headjoint, bodyjoint, and footjoint)

Pull one corner of the swab through the end of the cleaning rod. Wrap the remaining cloth around the cleaning rod.

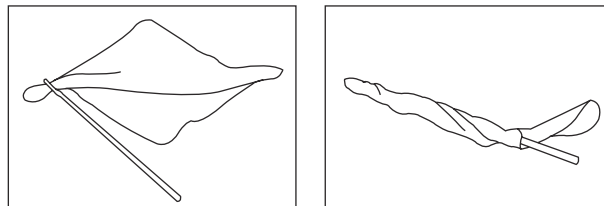

Insert the cleaning swab through the headjoint, bodyjoint, and footjoint to remove excess moisture.

3. How to clean/polish the flute's surface

Wipe the instrument's surface after playing with a soft polishing cloth. When wiping, hold the instrument carefully as to not damage delicate key mechanisms or pads.

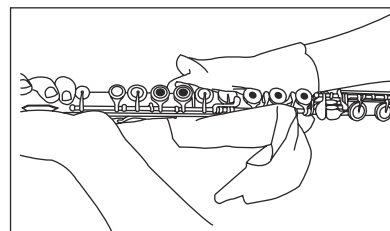

1. How to clean the Waveline bowjoint

Insert the beaded cleaning swab through the Waveline bowjoint assembly to remove excess moisture.

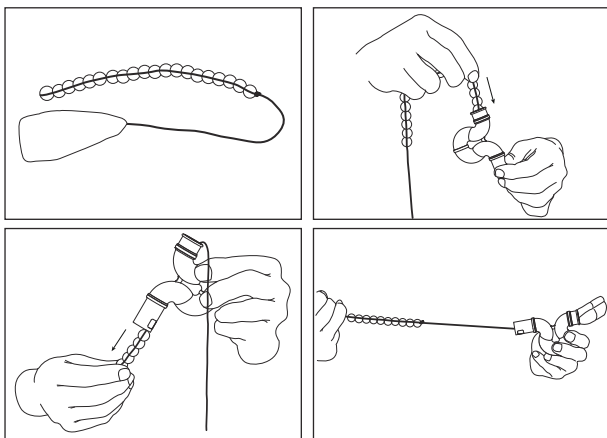

4 Optional Waveline™ Flute Extension Kit

Your Waveline™ C Flute can easily be changed into a full scale flute with a standard straight headjoint. All you need is the Waveline™ Extension Kit.

The Waveline™ Flute Extension Kit contains the following accessories:

JUPITER Waveline™ Flute Extension Barrel
JUPITER Straight Headjoint with .925 Sterling Riser
JUPITER Flute Case
JUPITER Flute Zippered Case Cover

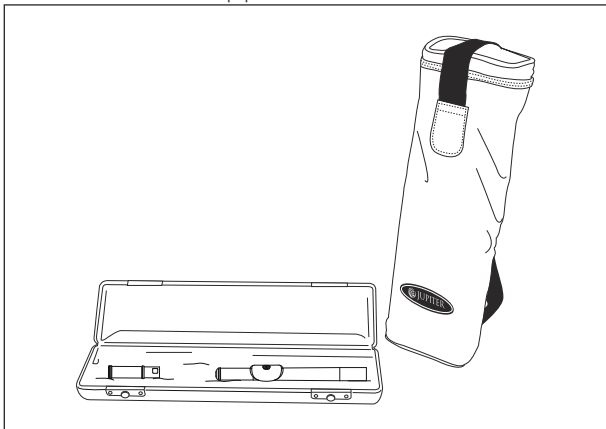

5 How to Use the Waveline™ Flute Extension Kit

1. Remove the Waveline bowjoint and headjoint

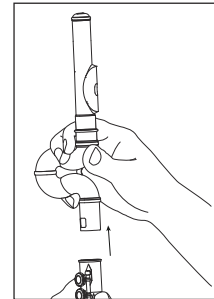

2. Insert the extension barrel.

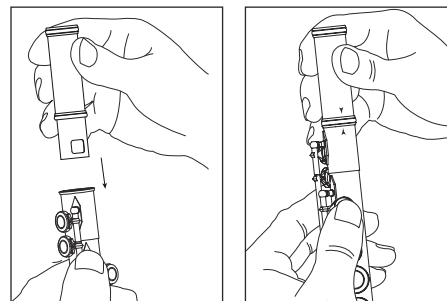

The specially engraved alignment indicators located on the headjoint and bodyjoint ensure correct assembly and optimum position placement.

3. Insert the straight headjoint. Your extended Waveline™ C Flute is now ready to play!

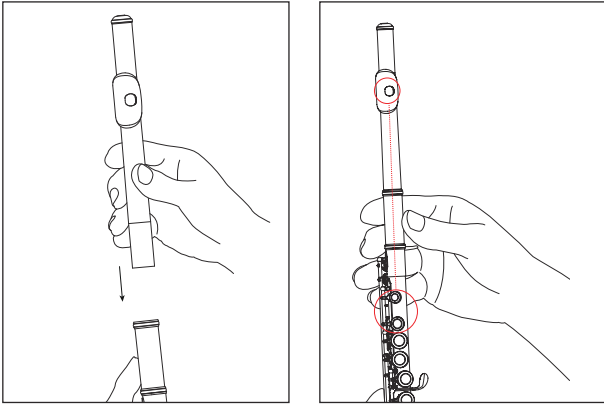

4. From now on you can use your extended Waveline™ C Flute as a regular straight flute. Simply remove the straight headjoint and footjoint (the extension barrel stays in the flute) and it will fit perfectly in your JUPITER flute case and case cover.

